

CUADERNILLO DEL
método DE LOS
20 días



MÉTODO DE LOS 20 DÍAS

El “Cuadernillo del método de los 20 días” le permitirá recuperar a sus alumnos que se han atrasado escolarmente con respecto al nivel de conocimiento de sus demás compañeros en el proceso de lecto-escritura.

Este procedimiento didáctico debe desarrollarlo siguiendo las indicaciones que le marca el presente documento ya que cada paso o actividad es determinante para el buen éxito en el aprendizaje del alumno. Usted (docente) podrá en el transcurso de su actividad realizar o introducir de acuerdo a su capacidad y experiencia, cambios en los pasos o actividades sin alterar sustancialmente los mismo.

La aplicación correcta de este procedimiento lo llevará a que en el término de un mes como máximo el alumno pueda leer y escribir más de 100 palabras y pequeños enunciados, integrándose a un nivel de conocimientos aceptable.











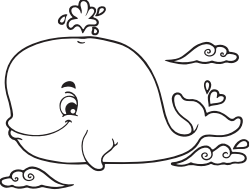

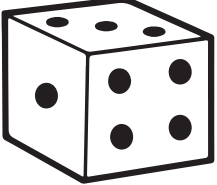

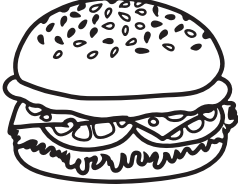

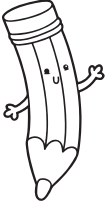

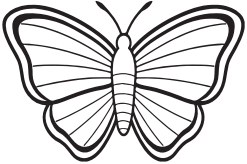
La aplicación del procedimiento didáctico se realizara de la siguiente manera:

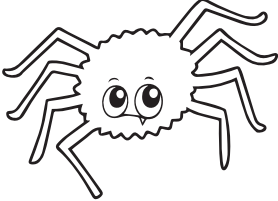
- Cada plantilla se trabaja durante cuatro días consecutivos.
- Se empieza a trabajar con la plantilla #1 de la letra “A-a”
- Se lee de la siguiente manera ba ba ba ballenita, ca ca ca casita, cha cha cha changuito, se hace así hasta llegar al último dibujo.
- Es muy importante que durante la lectura el niño(a) señale con su dedo índice la sílaba que se está leyendo y de tres toques con su dedo al leerla.
- Es recomendable trabajar con la lectura de la plantilla varias veces al día.
- Una vez concluida la lectura (varias veces) se procederá a realizar el dictado del día #1 (material anexo).
- Durante el dictado el alumno puede apoyarse en cualquier momento viendo su plantilla.
- Este procedimiento de lectura y dictado se llevara a cabo durante cuatro días consecutivos con la plantilla #1 de la letra “A-a” su única variación será las palabras que se dictaran cada día.
- Si incluyen además del anexo de dictado otras fichas para reforzar lo aprendido durante la semana. Cada una de ellas el docente las puede adecuar en el momento que crea indicado durante la aplicación del método.

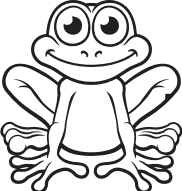
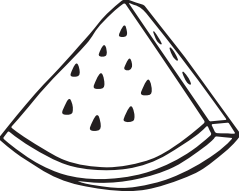
Todo este procedimiento se repite de la misma manera cada semana durante cuatro días con cada plantilla hasta llegar a la #5. (a-e-i-o-u).

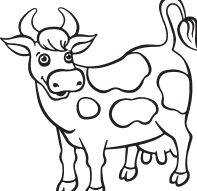
Agradecimientos a la Mtra. Nubia Ramírez.

PLANTILLA #1

 <p>ba</p>	 <p>ca</p>	 <p>cha</p>	 <p>da</p>
 <p>fa</p>	 <p>ga</p>	 <p>ha</p>	 <p>ja</p>
 <p>ka</p>	 <p>la</p>	 <p>lla</p>	 <p>ma</p>
 <p>na</p>	 <p>ña</p>	 <p>pa</p>	 <p>ra</p>
 <p>sa</p>	 <p>ta</p>	 <p>va</p>	 <p>wa</p>
<p>xa</p>	 <p>ya</p>	 <p>za</p>	<h1>Aa</h1>

DICTADO #1

Día 1

1. _____
2. _____
3. _____
4. _____
5. _____
6. _____
7. _____
8. _____
9. _____
10. _____

Día 2

1. _____
2. _____
3. _____
4. _____
5. _____
6. _____
7. _____
8. _____
9. _____
10. _____

Día 3



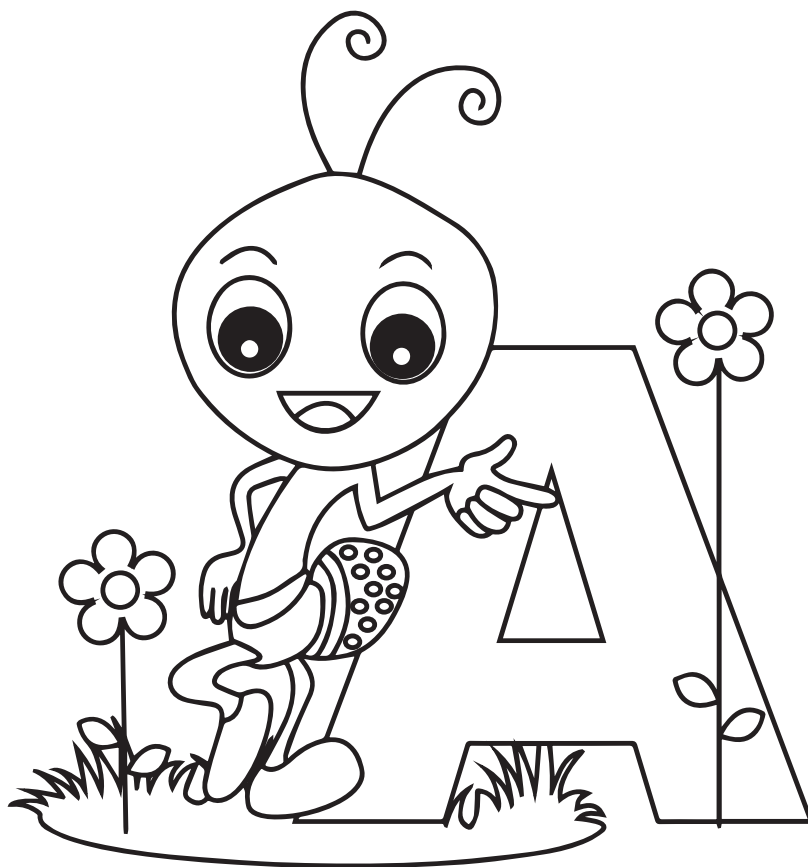

1. _____
2. _____
3. _____
4. _____
5. _____
6. _____
7. _____
8. _____
9. _____
10. _____

Día 4

1. _____
2. _____
3. _____
4. _____
5. _____
6. _____
7. _____
8. _____
9. _____
10. _____

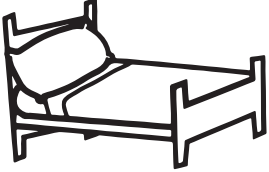
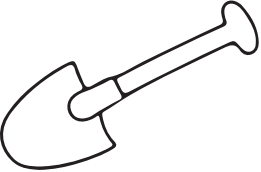

Construyendo palabras FICHA #1

	Construye	Escribe
		1
		2
		3
		1
		2
		3
		1
		2
		3
		1
		2
		3
		1
		2
		3



pa	sa	za	ca	ca
ma	ta	ca	la	va

FICHA #1

Lee con atención el siguiente texto y colorea el dibujo.

La mamá vaca
va a la casa
a bañar a la pata.











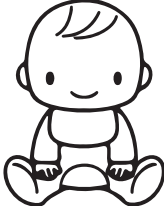
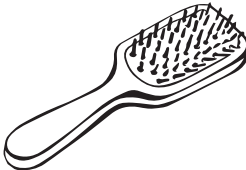

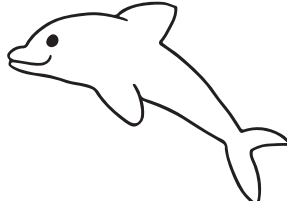

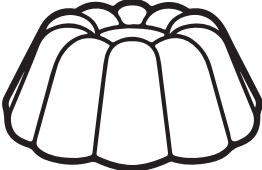

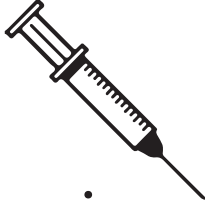

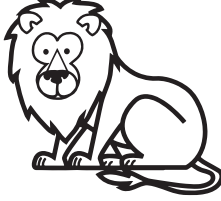
www.materialparamaestros.com

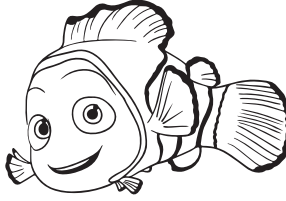

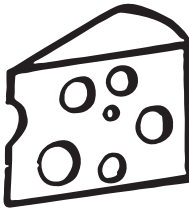
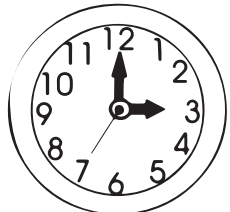
La nana Pancha
amasa pan
para la Chata.

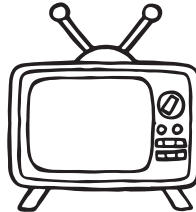
PLANTILLA #2

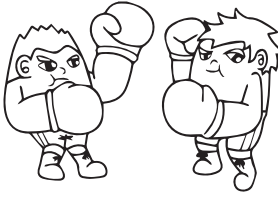
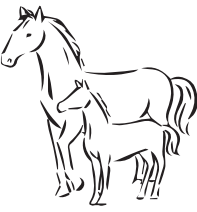
 be	 ce	 che	 de
 fe	 ge	 gue	 he
 je	 ke	 le	 lle
 me	 ne	 ñe	 pe
 que	 re	 se	 te
 ve	 xe	 ye	Ee

DICTADO #2

Día 1

1. _____
2. _____
3. _____
4. _____
5. _____
6. _____
7. _____
8. _____
9. _____
10. _____

Día 2

1. _____
2. _____
3. _____
4. _____
5. _____
6. _____
7. _____
8. _____
9. _____
10. _____

Día 3

1. _____
2. _____
3. _____
4. _____
5. _____
6. _____
7. _____
8. _____
9. _____
10. _____

Día 4

1. _____
2. _____
3. _____
4. _____
5. _____
6. _____
7. _____
8. _____
9. _____
10. _____

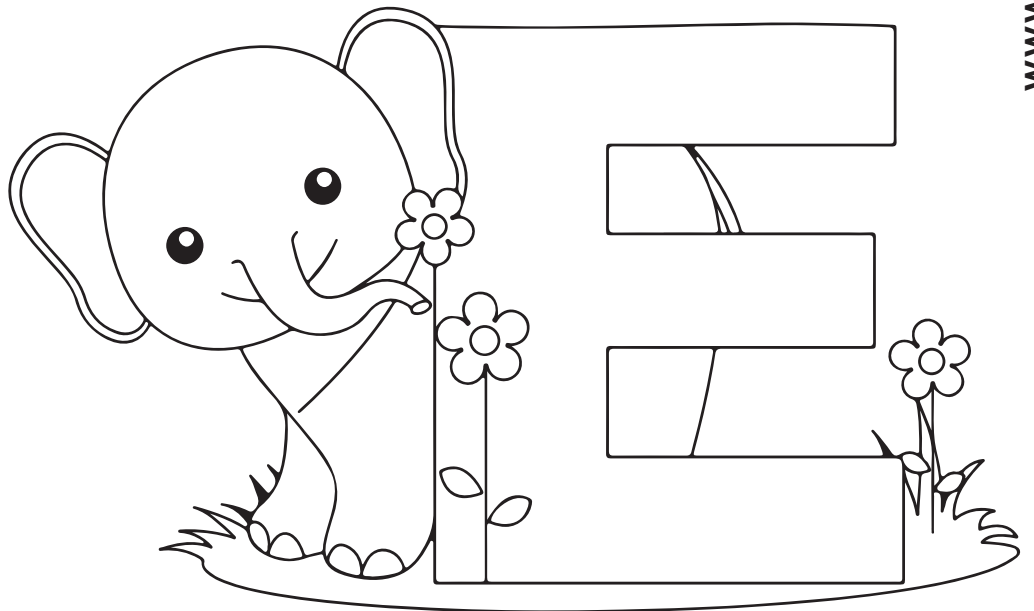

FICHA #2



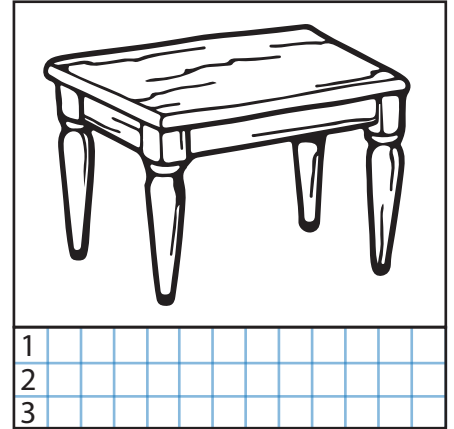
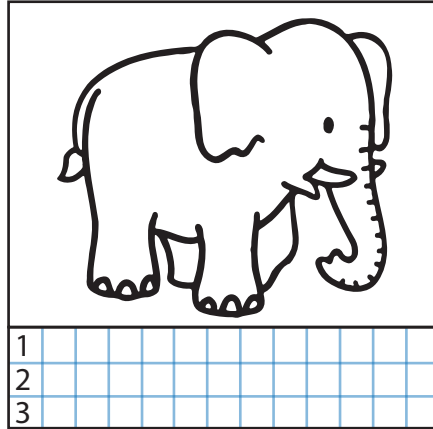
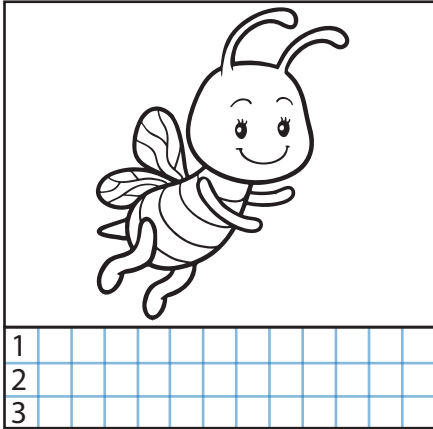

Escribe el nombre a cada dibujo y colorea los.

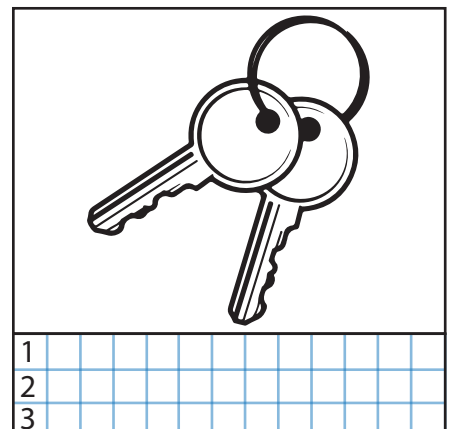
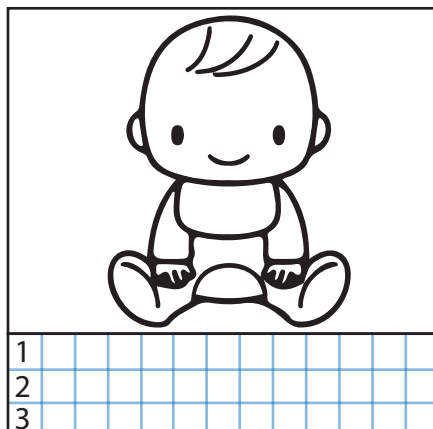
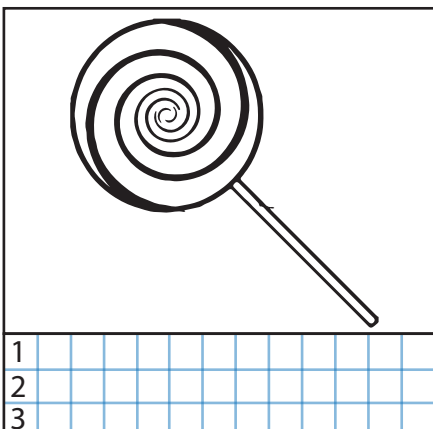
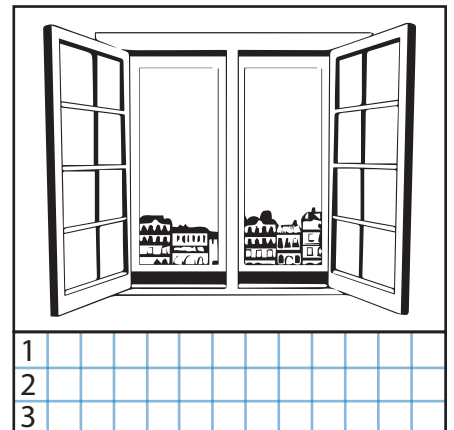
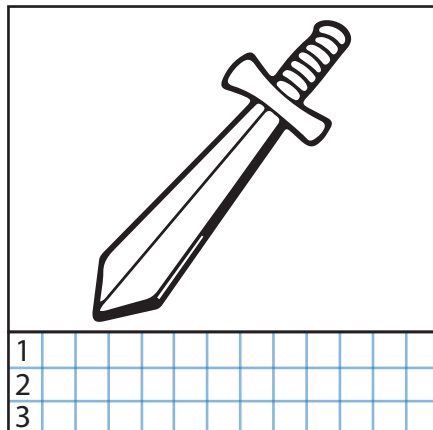
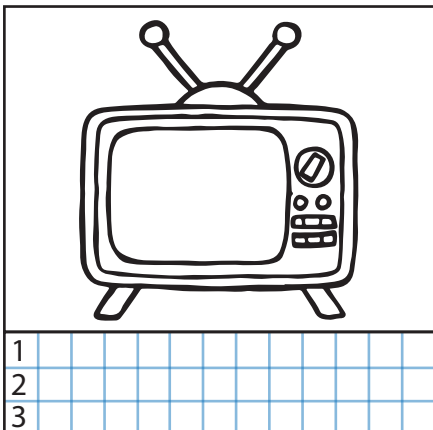

www.materialparamaestros.com

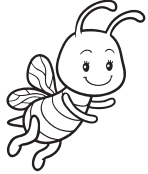

Construyendo palabras FICHA #2

	Construye	Escribe
	<div style="border: 1px dashed black; width: 100%; height: 100%;"></div>	1
		2
		3
	<div style="border: 1px dashed black; width: 100%; height: 100%;"></div>	1
		2
		3
	<div style="border: 1px dashed black; width: 100%; height: 100%;"></div>	1
		2
		3
	<div style="border: 1px dashed black; width: 100%; height: 100%;"></div>	1
		2
		3
	<div style="border: 1px dashed black; width: 100%; height: 100%;"></div>	1
		2
		3



me	sa	be	pa	ja	le	
le	te	pa	a	da	ta	es

FICHA #2





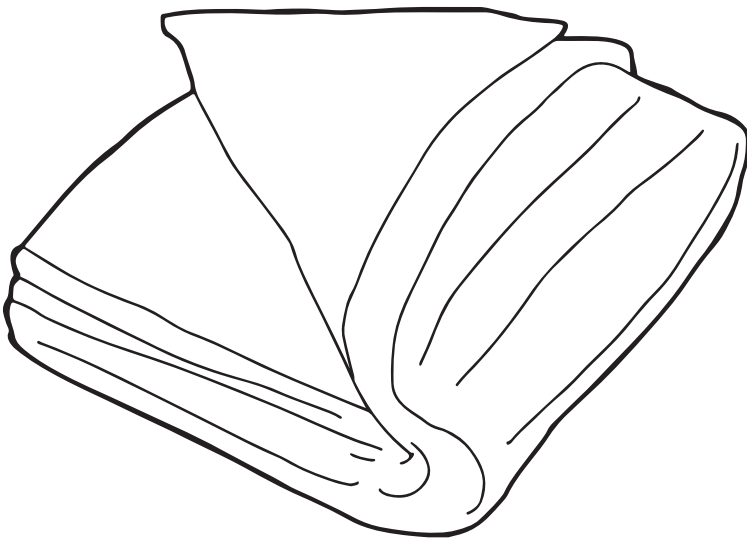









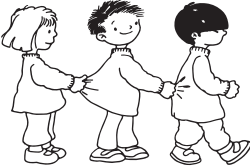



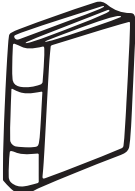

Lee con atención el siguiente texto y colorea el dibujo.

**En la maleta
está la paleta
de Malena.**

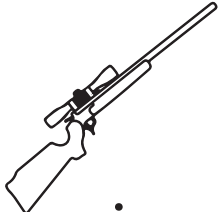

**Ella lleva tela
para la becerra.**

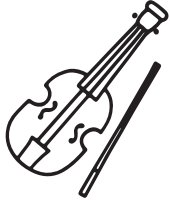
PLANTILLA #3

 <p>bi</p>	 <p>ci</p>	 <p>chi</p>	 <p>di</p>
 <p>fi</p>	 <p>gi</p>	 <p>gui</p>	 <p>hi</p>
 <p>ji</p>	 <p>ki</p>	 <p>li</p>	 <p>lli</p>
 <p>mi</p>	 <p>ni</p>	 <p>ñi</p>	 <p>pi</p>
 <p>qui</p>	 <p>ri</p>	 <p>si</p>	 <p>ti</p>
 <p>vi</p>	 <p>xi</p>	<p>yi</p>	<p>li</p>

DICTADO #3

Día 1

1. _____
2. _____
3. _____
4. _____
5. _____
6. _____
7. _____
8. _____
9. _____
10. _____

Día 2

1. _____
2. _____
3. _____
4. _____
5. _____
6. _____
7. _____
8. _____
9. _____
10. _____

Día 3

1. _____
2. _____
3. _____
4. _____
5. _____
6. _____
7. _____
8. _____
9. _____
10. _____

Día 4

1. _____
2. _____
3. _____
4. _____
5. _____
6. _____
7. _____
8. _____
9. _____
10. _____

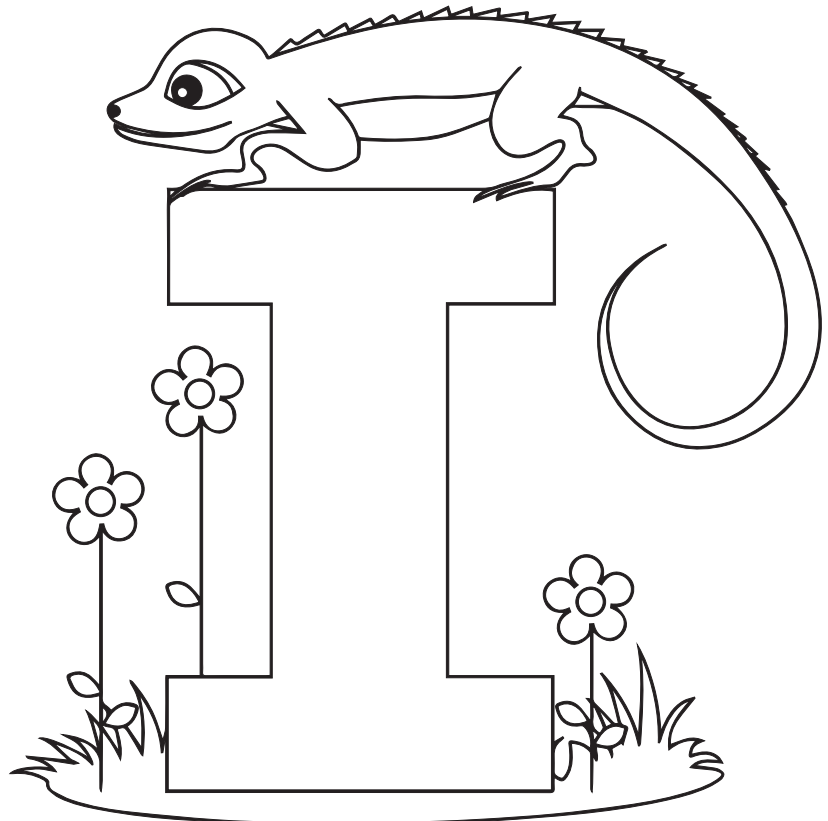

FICHA #3



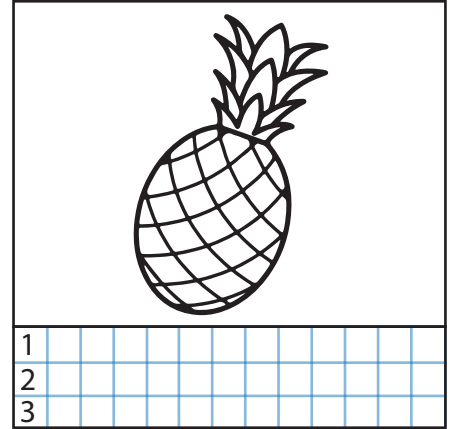
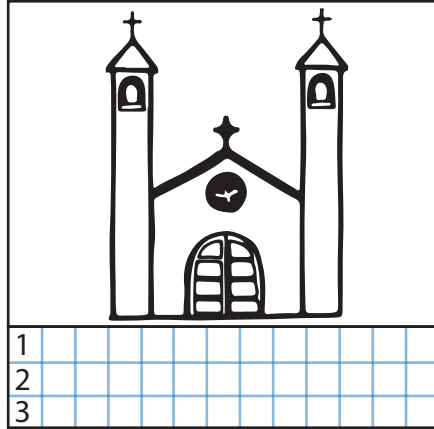
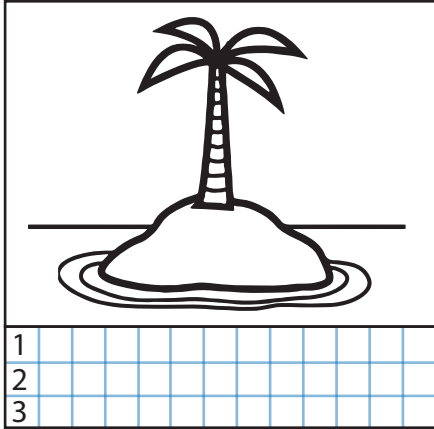

Escribe el nombre a cada dibujo y colorea los.

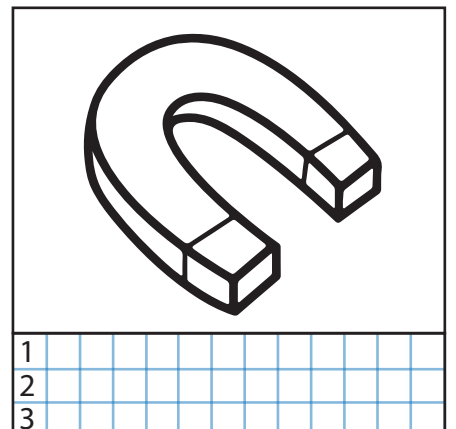
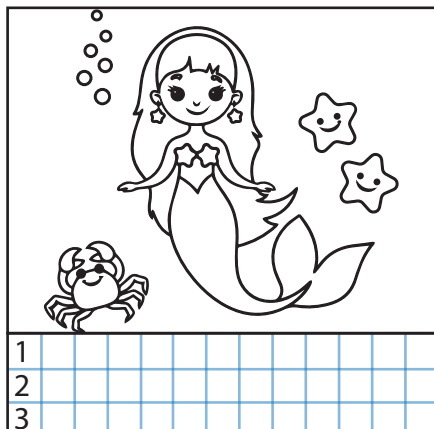
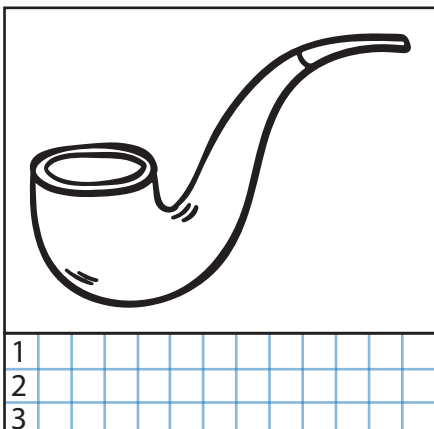
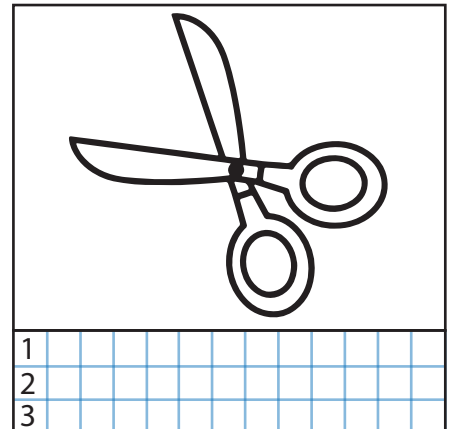
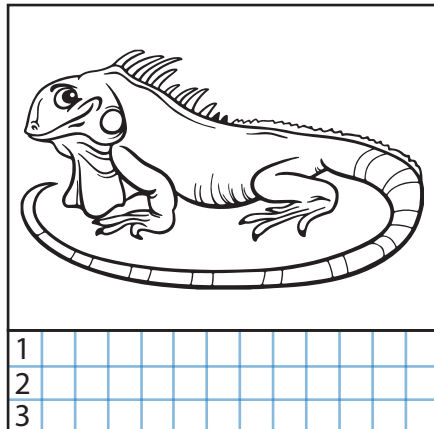
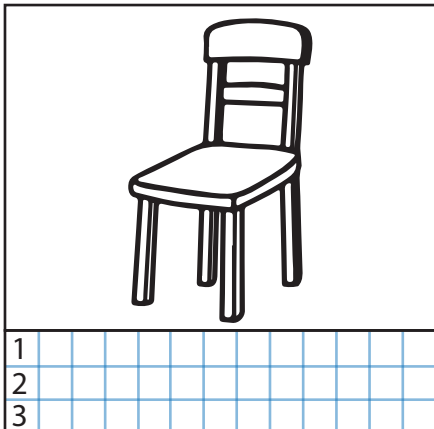

www.materialparamaestros.com

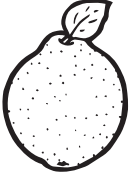

Construyendo palabras FICHA #3

	Construye	Escribe
		1
		2
		3
		1
		2
		3
		1
		2
		3
		1
		2
		3
		1
		2
		3



pi	si	li	pa	la
is	ma	pi	lla	ña

FICHA #3





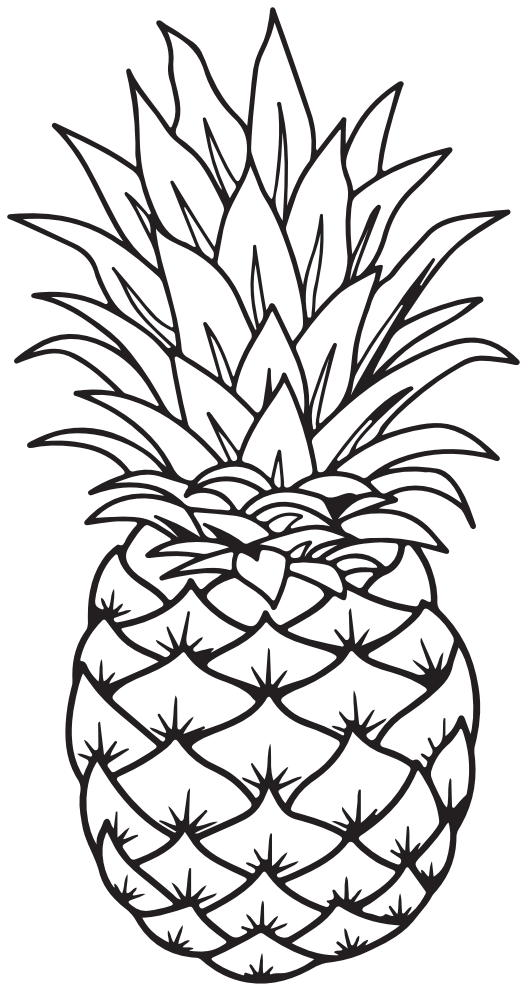
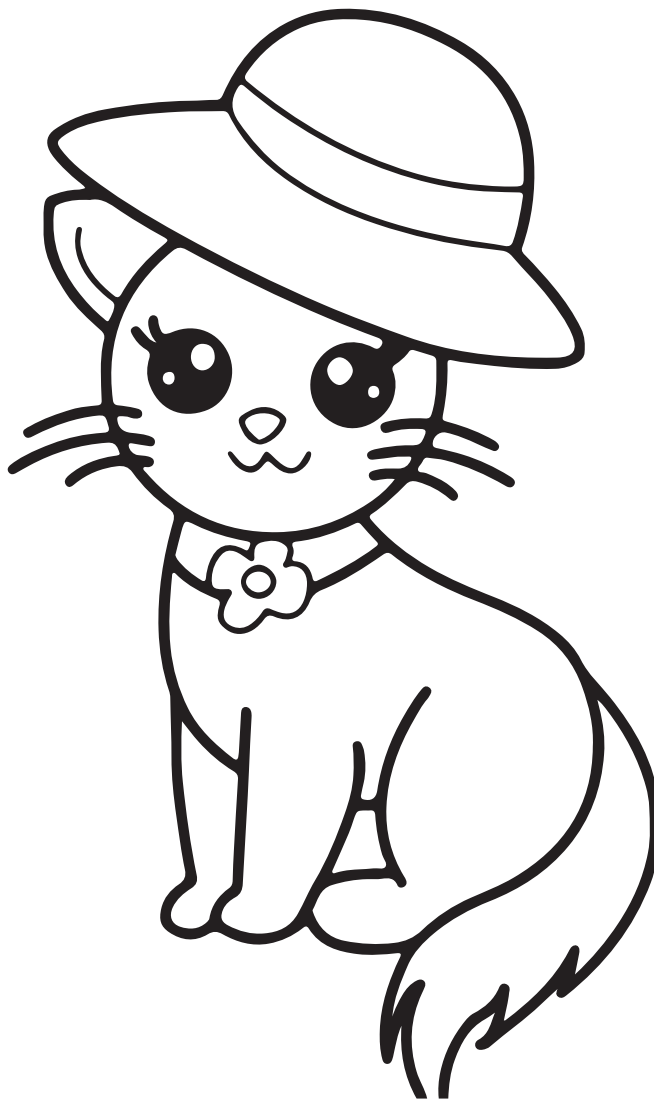





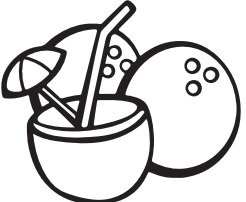
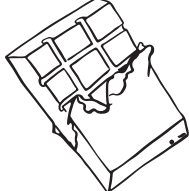
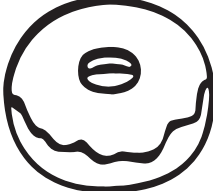
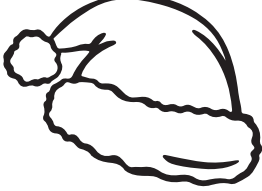
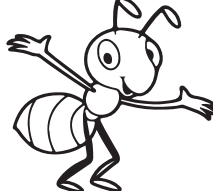

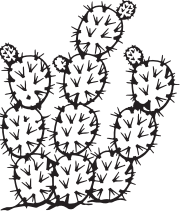

Lee con atención el siguiente texto y colorea el dibujo.

La niña Camila
cepilla a la
gatita Mimi.

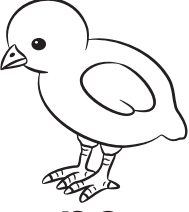

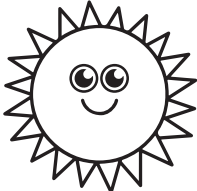
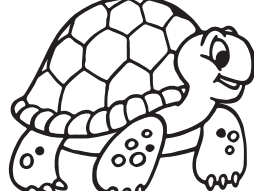
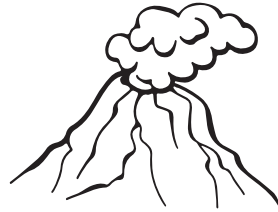
La rica piña
es de la niña Tita.

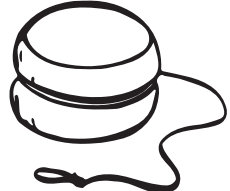
PLANTILLA #4

 <p>bo</p>	 <p>co</p>	 <p>cho</p>	 <p>do</p>
 <p>fo</p>	 <p>go</p>	 <p>ho</p>	 <p>jo</p>
 <p>ko</p>	 <p>lo</p>	 <p>llo</p>	 <p>mo</p>
 <p>no</p>	 <p>ño</p>	 <p>po</p>	 <p>ro</p>
 <p>so</p>	 <p>to</p>	 <p>vo</p>	<p>wo</p>
 <p>xo</p>	 <p>yo</p>	 <p>zo</p>	<p>Oo</p>

DICTADO #4

Día 1

1. _____
2. _____
3. _____
4. _____
5. _____
6. _____
7. _____
8. _____
9. _____
10. _____

Día 2

1. _____
2. _____
3. _____
4. _____
5. _____
6. _____
7. _____
8. _____
9. _____
10. _____

Día 3

1. _____
2. _____
3. _____
4. _____
5. _____
6. _____
7. _____
8. _____
9. _____
10. _____

Día 4

1. _____
2. _____
3. _____
4. _____
5. _____
6. _____
7. _____
8. _____
9. _____
10. _____

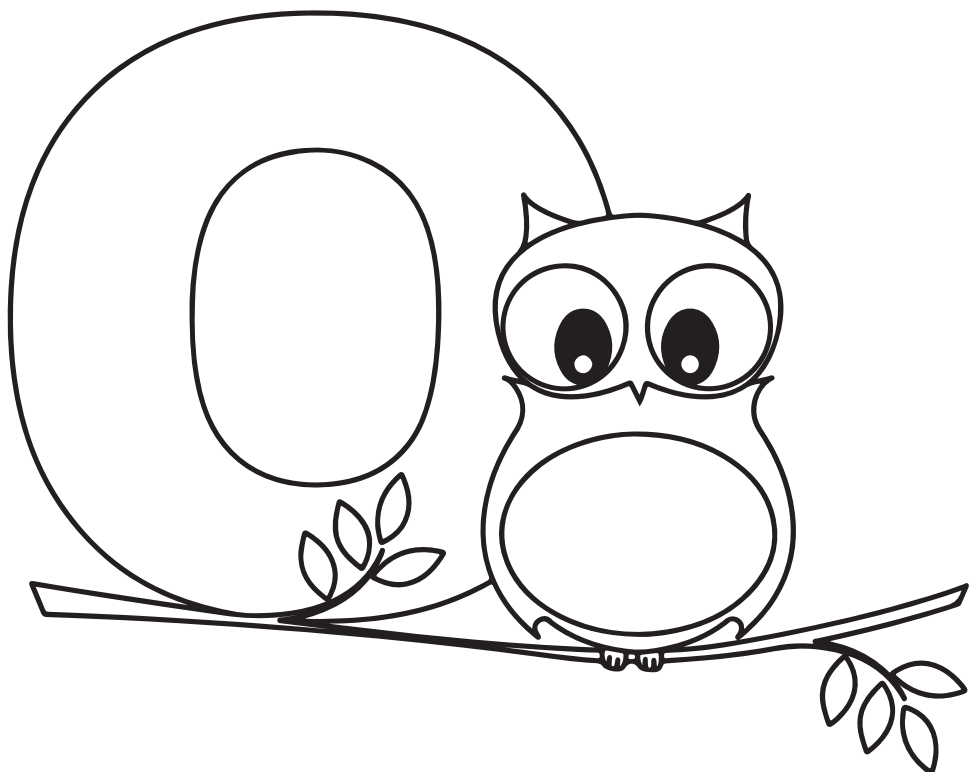

FICHA #4



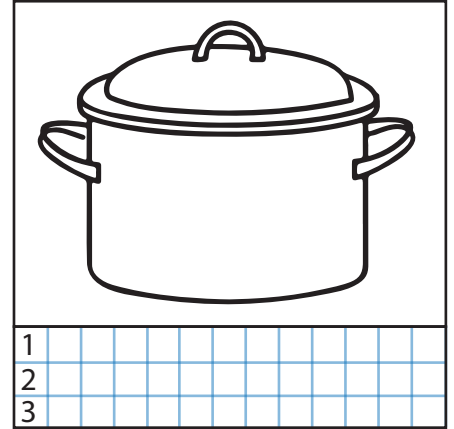
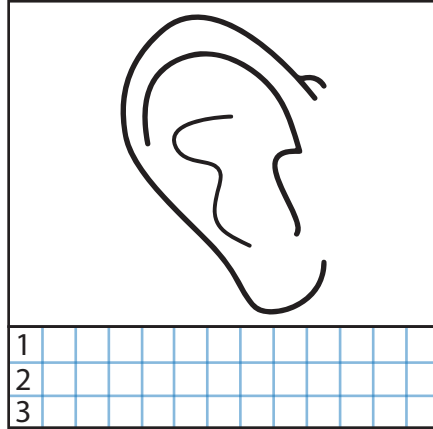
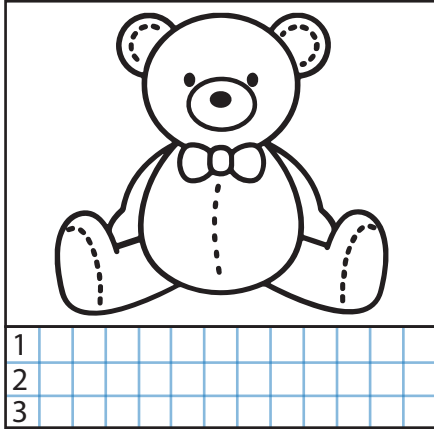

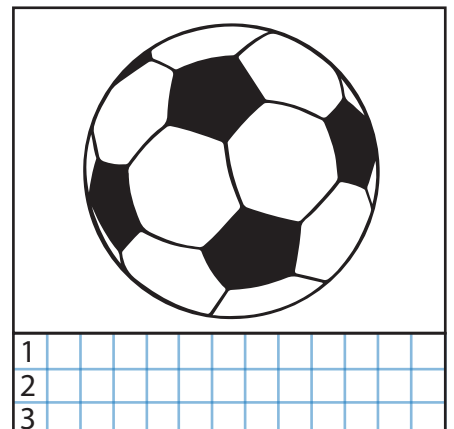
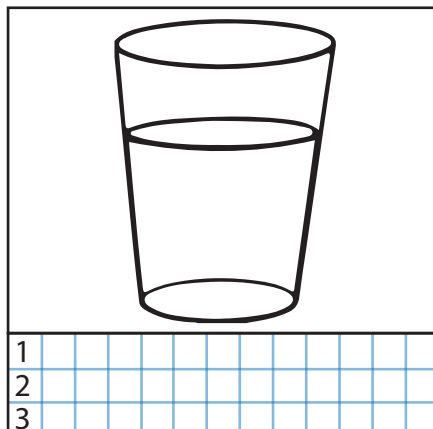
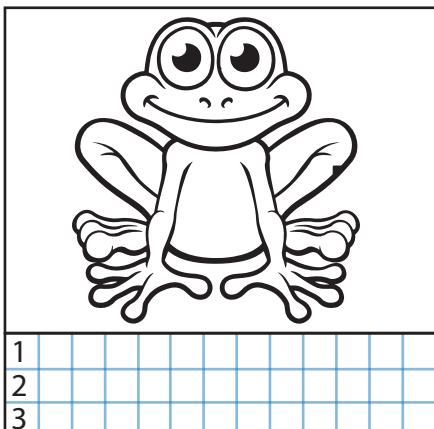
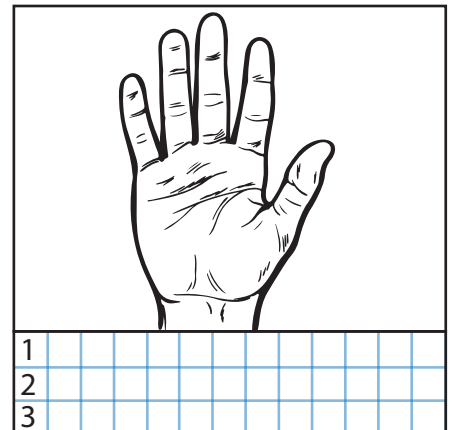
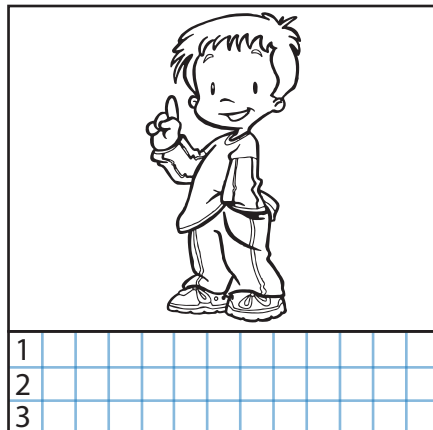
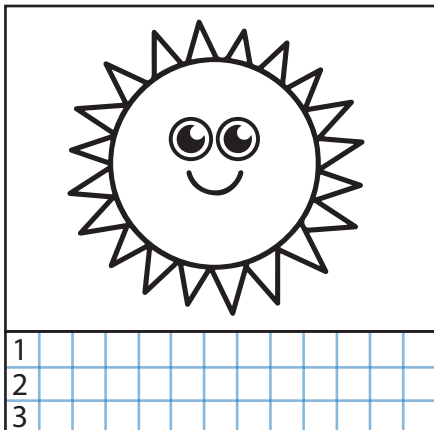

Escribe el nombre a cada dibujo y colorea los.

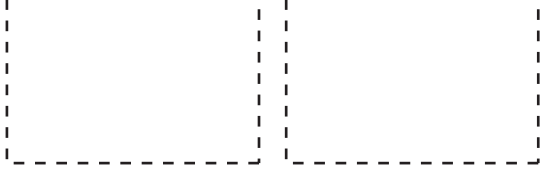

www.materialparamaestros.com

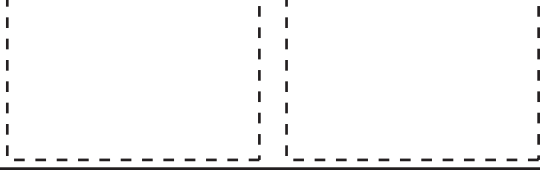
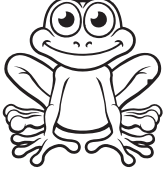

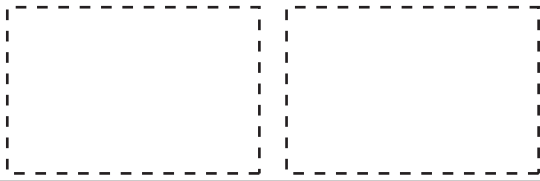
Construyendo palabras FICHA #4

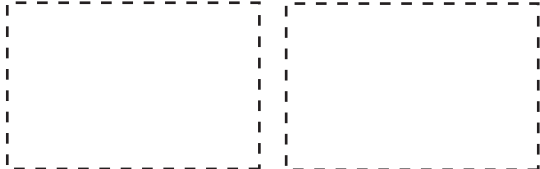
	Construye	Escribe
		1
		2
		3
		1
		2
		3
		1
		2
		3
		1
		2
		3
		1
		2
		3



ño	no	ni	no	so
sa	ma	po	mo	va

FICHA #4





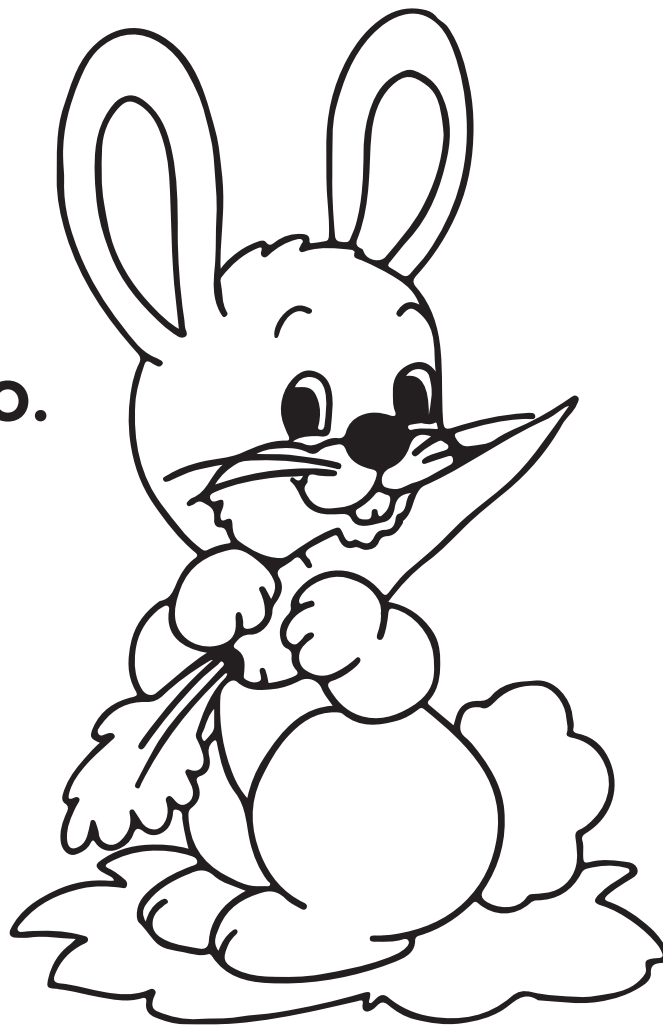
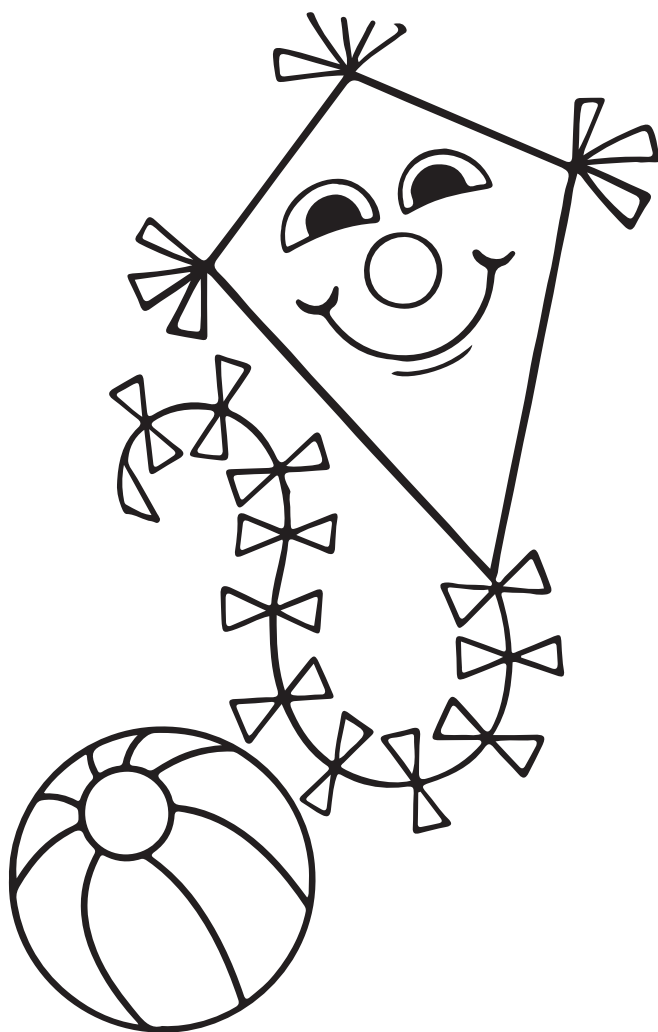



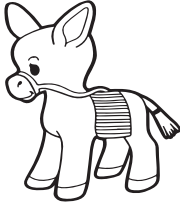
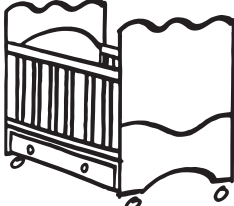
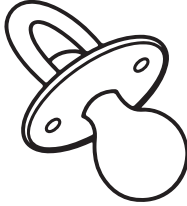
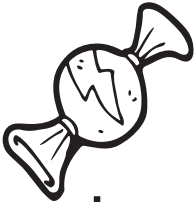

Lee con atención el siguiente texto y colorea el dibujo.

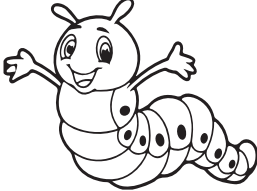
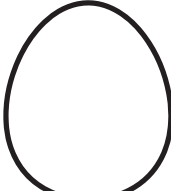
**Mi tío Oscar
saco un conejo
de ese sombrero.**

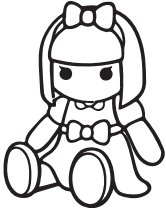
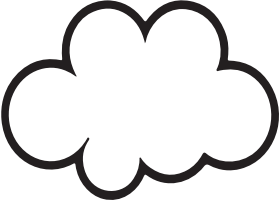
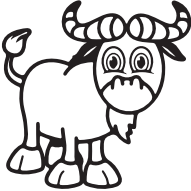
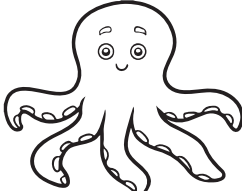
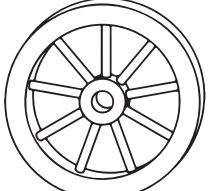
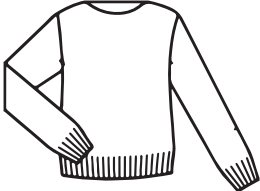

**Él se va con Lola
en moto de paseo
lleva la pelota,
lleva el papalote.**

PLANTILLA #5

 <p>bu</p>	 <p>cú</p>	 <p>chu</p>	 <p>du</p>
 <p>fu</p>	 <p>gu</p>	 <p>hu</p>	 <p>ju</p>
<p>ku</p>	 <p>lu</p>	 <p>llu</p>	 <p>mu</p>
 <p>nu</p>	 <p>ñu</p>	 <p>pu</p>	 <p>ru</p>
 <p>su</p>	 <p>tu</p>	 <p>vu</p>	<p>wu</p>
<p>xu</p>	<p>yu</p>	 <p>zu</p>	<h1>Uu</h1>

DICTADO #5

Día 1

- 1. _____
- 2. _____
- 3. _____
- 4. _____
- 5. _____
- 6. _____
- 7. _____
- 8. _____
- 9. _____
- 10. _____

Día 2

- 1. _____
- 2. _____
- 3. _____
- 4. _____
- 5. _____
- 6. _____
- 7. _____
- 8. _____
- 9. _____
- 10. _____

Día 3

- 1. _____
- 2. _____
- 3. _____
- 4. _____
- 5. _____
- 6. _____
- 7. _____
- 8. _____
- 9. _____
- 10. _____

Día 4

- 1. _____
- 2. _____
- 3. _____
- 4. _____
- 5. _____
- 6. _____
- 7. _____
- 8. _____
- 9. _____
- 10. _____



FICHA #5



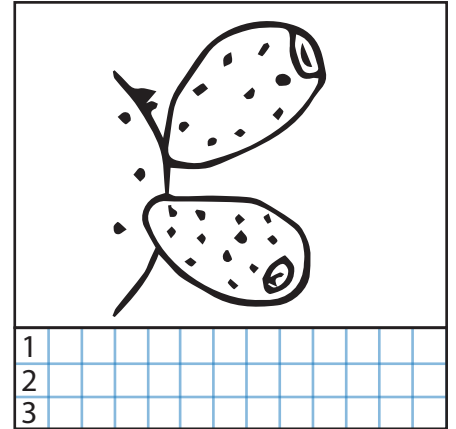
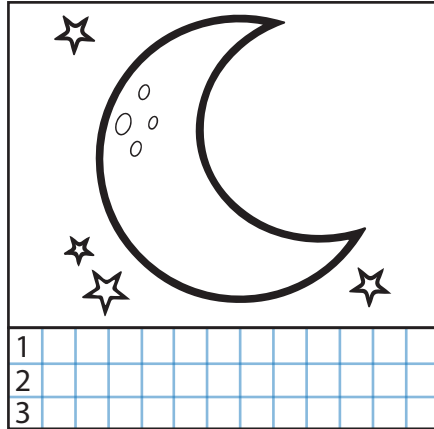
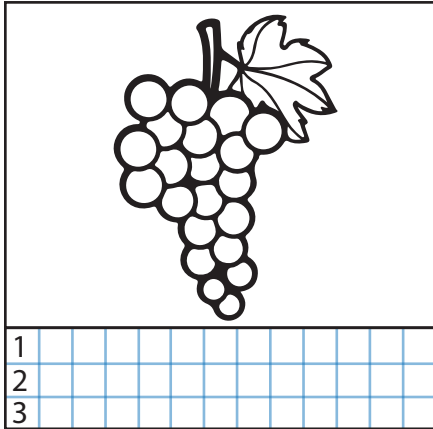

Escribe el nombre a cada dibujo y colorea los.

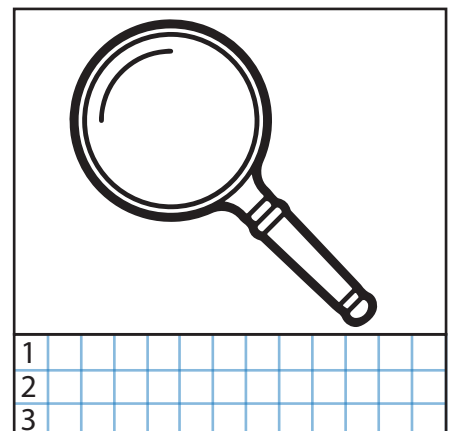
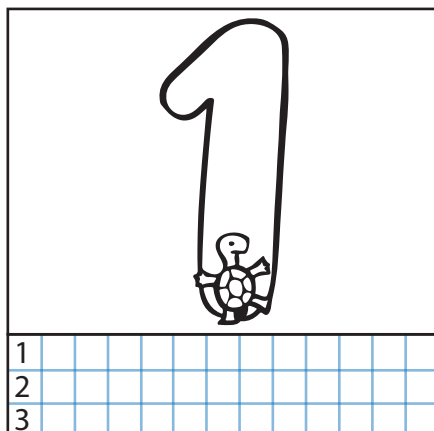
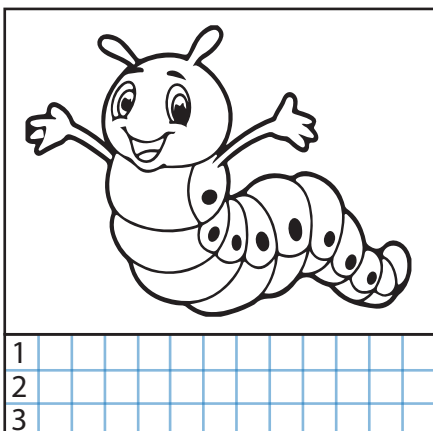
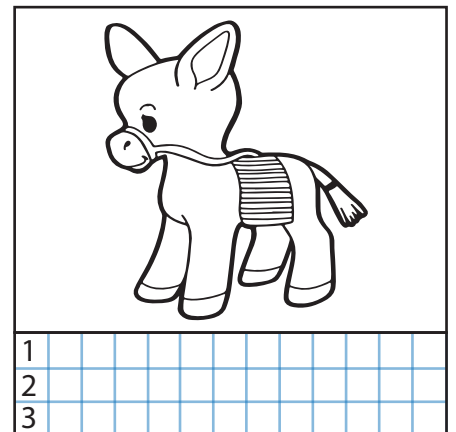
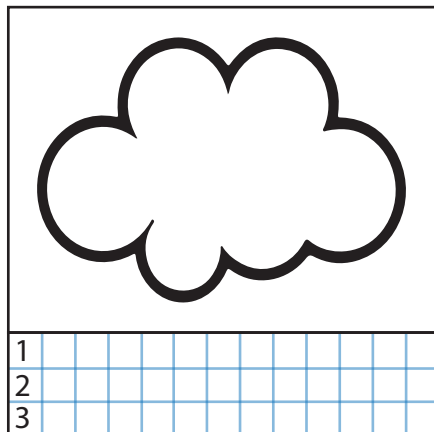
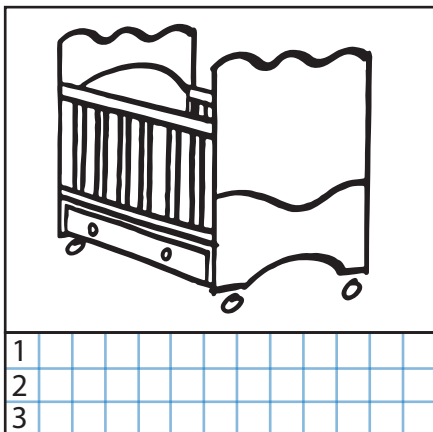

www.materialparamaestros.com

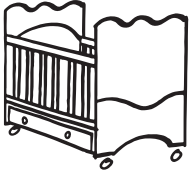

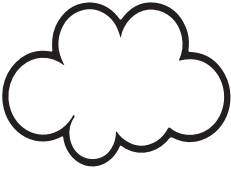
Construyendo palabras FICHA #5

	Construye	Escribe
	<div style="border: 1px dashed black; width: 100%; height: 100%;"></div>	1
		2
		3
	<div style="border: 1px dashed black; width: 100%; height: 100%;"></div>	1
		2
		3
	<div style="border: 1px dashed black; width: 100%; height: 100%;"></div>	1
		2
		3
	<div style="border: 1px dashed black; width: 100%; height: 100%;"></div>	1
		2
		3
	<div style="border: 1px dashed black; width: 100%; height: 100%;"></div>	1
		2
		3



rro	nu	na	cu	cu
be	bu	na	tu	na

FICHA #5

Lee con atención el siguiente texto y colorea el dibujo.

La niña Úrsula
toma su tortuga
o su gusano.
Su abuelo se lo dio.

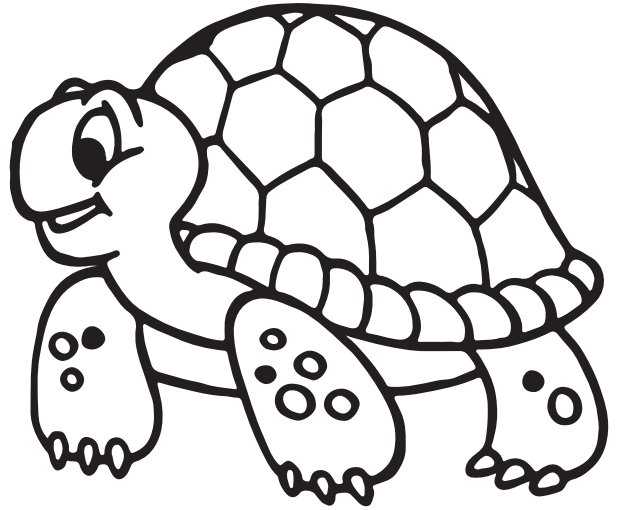

Raúl mira la luna
a las nueve
por la cuna.

Raúl y Úrsula
toman agua
de la fuente.



ANEXOS

DICTADOS DE PALABRAS

PALABRAS CON A

Día 1	Día 2	Día 3	Día 4
bata pata lata masa casa taza nata mala ataca papaya	mata ala ama vaca tala sana sala lala patada amarra	tapa capa saca nara maña llama fama tata callada sabana	dama gata gasa paca rata rasa parra caña cañada calabaza

PALABRAS CON A-E

Día 1	Día 2	Día 3	Día 4
peca yate lame mela tela llave peña carreta calabaza petate	esa ese llema vena pera para gema pecera tetera carretera	beba ceca fea lema pena reta tape carrete melaza pepena	rema tema sale perra leña nena lamen pelea paleta maleta

PALABRAS CON A-E-I

Día 1	Día 2	Día 3	Día 4
bibi bici chile Lili mini fin Sisi mil sirena tijera	lima chiva dina silla fina mía chema pita mamila Camila	mecha gira miel rifa jinete risa jícama lechita Geremías niñita	gatita damita llavecita bebida cabecita perrita jirafa Melisa Teresa escuelita

PALABRAS CON A-E-I-O

Día 1	Día 2	Día 3	Día 4
oso oreja ocho Oscar saco sola sopa vaso moneda mariposa	ola sapo pato mano hongo moto mono lola soldado sombrero	ojo lobo loro león elote atole melón limón paloma pillito	olla pelo pino solo pozo osa paseo pelota papalote tomate

PALABRAS CON A-E-I-O-U

Día 1	Día 2	Día 3	Día 4
uno muela mula suma lupa luna suelo puma gusano tortuga	uña tuna tubo nube ruta nueve duele cubeta uniforme Úrsula	usa burro vuela Rubí Raúl rueda una cuna abuelo vuelta	uvas fuente cuento nudo duro mucho puño pañuelo último cuaderno

DICTADOS DE ORACIONES

Dictado 1

La mamá vaca va a la casa.

Lala va a la cama.

La nana Pancha amasa la pan para la Chata.

Dictado 2

En la maleta está la paleta.

Llevate la tele a la mesa.

La medalla es de tela para la becerria.

Dictado 3

Mireya camina en la piscina.

La niña Camila cepilla a la gallina.

Esta rica la piña de niña Tita.

Dictado 4

Orcar saco un conejo de ese sombrero.

Él se va con Loca en moto de paseo.

Lleva la pelota, lleva el papalote.

Dictado 5

Úrsula toma su tortuga o su gusano.

Raúl mira la luna en la cuna a las nueve.

Raúl y Úrsula toman agua de la fuente.